

HORO

design by SILVIA PAOLA PENNACCHIO



● GR-94 / Metallic grey / Textured



Discharge lamp floodlight for indoor and outdoor lighting, comprising:

- Die-cast aluminum housing chemically pre-treated and painted with polyester powder coating
- Flat extra clear tempered glass diffuser
- Extra pure polished aluminium reflectors
- Anti-ageing silicone gasket
- Automatic line isolator switch in LCP
- Electrical connection box in black technopolymer
- Ceramic lamp supports with stainless steel check spring
- Stainless steel locking springs for the glass
- Stainless steel external screws
- Fully integrated stainless steel safety spring clips
- Mounting bracket in hot dip galvanised steel
- Patented anti-vacuum device
- HR versions are supplied with a Hot Restrike ignitor for instantaneous re-start of the lamp
- Adequate power supply units, available as accessories, must be used for all floodlights

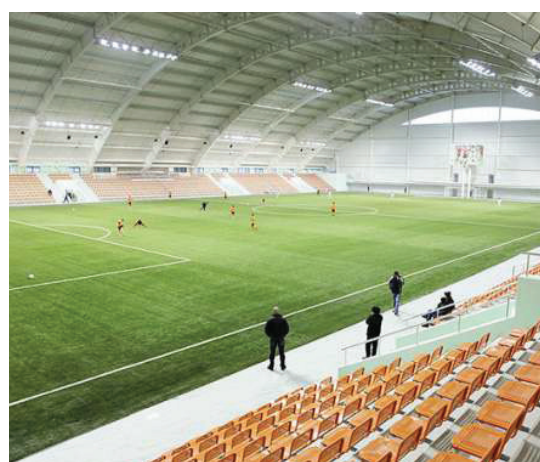

**HORO
A/I**
2000 W
1000 W



**HORO
HR A/I**
2000 W



**HORO
A/M**
2000 W
1000 W



**HORO
HR A/M**
2000 W
1000 W



**HORO
A/W**
2000 W

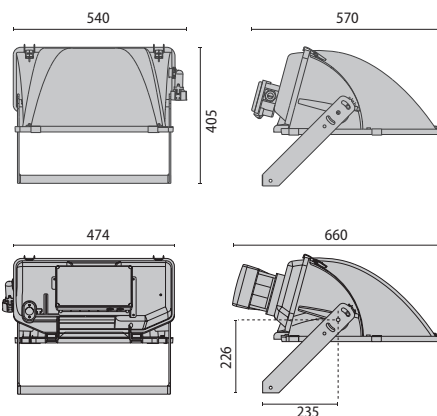

HORO 1000 A/I

IK09 12J xx7

LAMPHOLDER	WATTAGE	CLASS		CRI	KELVIN	COS ϕ $\geq 0,9$	OPTIC	OPTIC BEAM	LIGHTSOURCE LUMEN OUTPUT	LUMINAIRE LUMEN OUTPUT	L	B	LIFETIME	COLOUR/ RAL	PART NUMBER
Discharge - cabled with igniter															
E40	1x1000 W	I	•	-	-	-	A45/I	-	-	-	-	-	-	●	04022994
Discharge - cabled with ignitor for MHN-LA lamp															
cabl	1x1000 W	I	•	-	-	-	A45/I	-	-	-	-	-	-	●	04022494
Discharge - cabled with igniter for MHN-FC lamp															
cabl	1x1000 W	I	•	-	-	-	A45/I	-	-	-	-	-	-	●	04022594
Discharge - equipped with igniter for HQI-TS D/S LAMP															
cabl	1x1000 W	I	•	-	-	-	A45/I	-	-	-	-	-	-	●	04022394



HORO 1000 A/M

IK09 12J xx7

LAMPHOLDER	WATTAGE	CLASS		CRI	KELVIN	COS ϕ $\geq 0,9$	OPTIC	OPTIC BEAM	LIGHTSOURCE LUMEN OUTPUT	LUMINAIRE LUMEN OUTPUT	L	B	LIFETIME	COLOUR/ RAL	PART NUMBER
Discharge - cabled with igniter															
E40	1x1000 W	I	•	-	-	-	A45/M	-	-	-	-	-	-	●	04023094
Discharge - cabled with ignitor for MHN-LA lamp															
cabl	1x1000 W	I	•	-	-	-	A45/M	-	-	-	-	-	-	●	04022794
Discharge - cabled with igniter for MHN-FC lamp															
cabl	1x1000 W	I	•	-	-	-	A45/M	-	-	-	-	-	-	●	04022894
Discharge - equipped with igniter for HQI-TS D/S LAMP															
cabl	1x1000 W	I	•	-	-	-	A45/M	-	-	-	-	-	-	●	04022694



HORO 1000 HR A/M

IK09 12J xx7

LAMPHOLDER	WATTAGE	CLASS		CRI	KELVIN	COS ϕ $\geq 0,9$	OPTIC	OPTIC BEAM	LIGHTSOURCE LUMEN OUTPUT	LUMINAIRE LUMEN OUTPUT	L	B	LIFETIME	COLOUR/ RAL	PART NUMBER
Discharge - equipped with Hot Restrike igniter for HQI-TS D/S LAMP															
cabl	1x1000 W	I	•	-	-	-	A45/M	-	-	-	-	-	-	●	04025094

HORO 2000 A/I

IK09 12J xx7

LAMPHOLDER	WATTAGE	CLASS		CRI	KELVIN	COS ϕ $\geq 0,9$	OPTIC	OPTIC BEAM	LIGHTSOURCE LUMEN OUTPUT	LUMINAIRE LUMEN OUTPUT	L	B	LIFETIME	COLOUR/ RAL	PART NUMBER
Discharge - cabled with ignitor for MHN-LA lamp															
cabl	1x2000 W	I	•	-	-	-	A45/I	-	-	-	-	-	-	●	04021794
Discharge - cabled with igniter for MHN-FC lamp															
cabl	1x2000 W	I	•	-	-	-	A45/I	-	-	-	-	-	-	●	04021894
Discharge - equipped with igniter for HQI-TS D/S LAMP															
cabl	1x2000 W	I	•	-	-	-	A45/I	-	-	-	-	-	-	●	04021594
Discharge - cabled with igniter for HQI-TS N/L lamp															
cabl	1x2000 W	I	•	-	-	-	A45/I	-	-	-	-	-	-	●	04021694



HORO 2000 HR A/I

IK09 12J xx7

LAMPHOLDER	WATTAGE	CLASS		CRI	KELVIN	COS ϕ $\geq 0,9$	OPTIC	OPTIC BEAM	LIGHTSOURCE LUMEN OUTPUT	LUMINAIRE LUMEN OUTPUT	L	B	LIFETIME	COLOUR/ RAL	PART NUMBER
Discharge - equipped with Hot Restrike igniter for HQI-TS D/S LAMP															
cabl	1x2000 W	I	•	-	-	-	A45/I	-	-	-	-	-	-	●	04023194

HORO 2000 A/M

IK09 12J xx7

LAMPHOLDER	WATTAGE	CLASS		CRI	KELVIN	COS ϕ $\geq 0,9$	OPTIC	OPTIC BEAM	LIGHTSOURCE LUMEN OUTPUT	LUMINAIRE LUMEN OUTPUT	L	B	LIFETIME	COLOUR/ RAL	PART NUMBER
Discharge - cabled with ignitor for MHN-LA lamp															
cabl	1x2000 W	I	•	-	-	-	A45/M	-	-	-	-	-	-	●	04022194
Discharge - cabled with igniter for MHN-FC lamp															
cabl	1x2000 W	I	•	-	-	-	A45/M	-	-	-	-	-	-	●	04022294
Discharge - equipped with igniter for HQI-TS D/S LAMP															
cabl	1x2000 W	I	•	-	-	-	A45/M	-	-	-	-	-	-	●	04021994
Discharge - cabled with igniter for HQI-TS N/L lamp															
cabl	1x2000 W	I	•	-	-	-	A45/M	-	-	-	-	-	-	●	04022094



HORO 2000 HR A/M

IK09 12J xx7

LAMPHOLDER	WATTAGE	CLASS		CRI	KELVIN	COS ϕ $\geq 0,9$	OPTIC	OPTIC BEAM	LIGHTSOURCE LUMEN OUTPUT	LUMINAIRE LUMEN OUTPUT	L	B	LIFETIME	COLOUR/ RAL	PART NUMBER
Discharge - equipped with Hot Restrike igniter for HQI-TS D/S LAMP															
cabl	1x2000 W	I	•	-	-	-	A45/M	-	-	-	-	-	-	●	04023294

HORO 2000 A/W

IK09 12J xx7

LAMPHOLDER	WATTAGE	CLASS		CRI	KELVIN	COS ϕ $\geq 0,9$	OPTIC	OPTIC BEAM	LIGHTSOURCE LUMEN OUTPUT	LUMINAIRE LUMEN OUTPUT	L	B	LIFETIME	COLOUR/ RAL	PART NUMBER
Discharge - not cabled for lamp HQI-T D/I															
E40	1x2000 W	I	•	-	-	-	A45/W	-	-	-	-	-	-	●	01062594



CONTROL GEAR

DESCRIPTION	COLOR	PART NUMBER
HORO 1000 HQI-TS D/S / MHN-LA / MHN-FC / ST Aluminium power supply unit IP65, 230 V - 50 Hz, class I, for 1000W high pressure sodium and metal halide lamps with fuse and without ignitor	●	14013320
Power supply unit with aluminium base and polyamide cover IP65, 230 V - 50 Hz, class I, for 1000 W high pressure sodium and metal halide lamps with fuse and without ignitor	●	14215003
Power supply unit 230 V - 50Hz, class I, on galvanised steel plate for high pressure sodium and metal halide lamps with fuse and without ignitor		14020701
Set includes power supply unit and power-factor capacitor for 1000W high pressure sodium and metal halide lamp, 230V 50 Hz		14260003
HORO 2000 HQI-TS D/S Aluminium power supply unit IP65, 400 V - 50 Hz, class I, for 2000 W HQI-TS D/S lamps without ignitor	●	14014394
HORO 2000 HQI-TS D/S / HQI-TS N/L / MHN-LA / MHN-FC Power supply unit 400 V - 50 Hz, class I, on galvanised steel plate for 2000W metal halide lamps (not for HQI-TS and HQI-TS High Flux) with fuse and without ignitor		14020601
Set including power supply unit and power-factor capacitor for 2000W HQI-TS 400V 50 Hz lamp		14014420
HORO 2000 HQI-TS N/L / MHN-LA / MHN-FC Aluminium power supply unit IP65, 400 V - 50 Hz, class I, for 2000 W HQI-T / MHN-LA / MHN-FC / HQI-TS N/L metal halide lamps (not for HQI-TS and HQI-TS High Flux), without ignitor	●	14106003

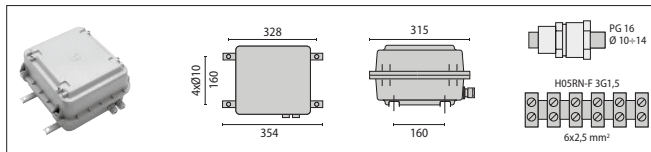

14013320 - 14014394 - 14106003

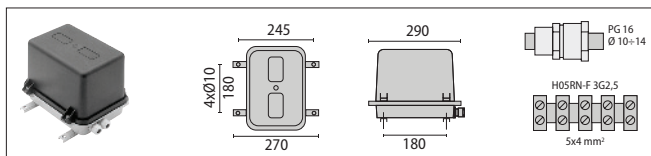

14215003

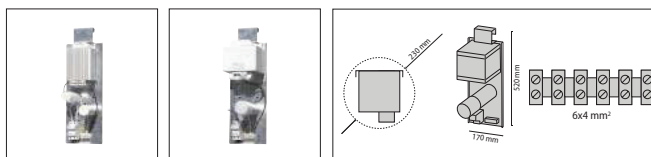

14020701

14020601

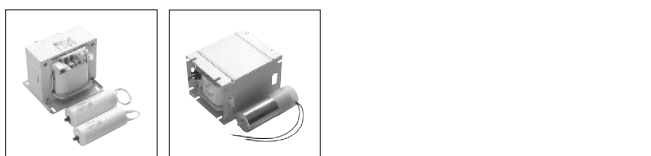

14260003

14014420

OPTIONAL ACCESSORIES

DESCRIPTION	COLOR	PART NUMBER
HORO External cowl in sheet aluminium, provides full cut off with peak beam max 55° and reduces upward light pollution.	●	14090394
External cowl in sheet aluminium, provides full cut off with peak beam max 60° and reduces upward light pollution.	●	14090494
External cowl in sheet aluminium, provides full cut off with peak beam max 65° and reduces upward light pollution.	●	14090594
Long mounting bracket in hot dipped galvanised steel suitable for use when mounting one floodlight above another to avoid interference of light distribution.		14090202
Horo viewfinder		14159204

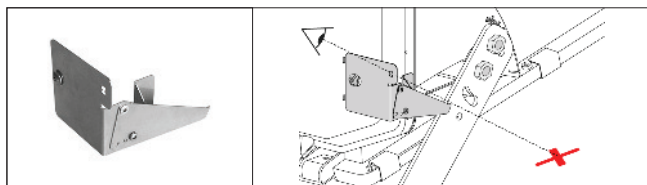
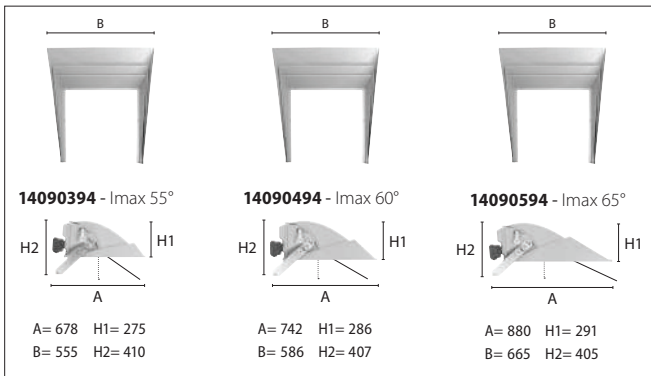

14159204

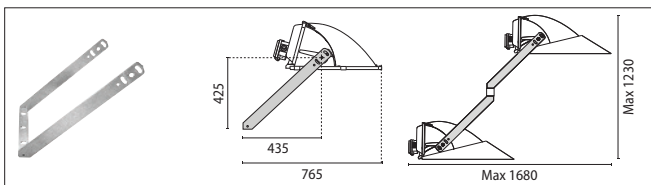

14090202

<p>HORO</p> <p>max 14 kg</p>	<p>HORO</p> <p>0,115 m²</p> <p>0,155 m²</p>	<p>HORO HR</p> <p>0,130 m²</p> <p>0,155 m²</p>	<p>±25° 0° -5°</p> <p>474 300 3 x Ø 21</p>	<p>Min 100 Min 30</p>	<p>M25 x 1,5 Ø 9 ÷ 14</p> <p>H07RN-F 3G2,5 3 x 2,5 mm²</p>
<p>HORO HR</p> <p>max 16 kg</p>	<p>0,285 m²</p>	<p>0,285 m²</p>			